

5-BAND GRAPHIC EQUALIZER AMPLIFIER

The KA2223 is a monolithic integrated circuit consisting of an operational amplifier with five resonant circuits and a active filter, and it is suitable for radio-cassette tape recorders, car stereos or music center audio systems.

FEATURES

- Tone control with independent adjustment of each band through an external capacitor.
- Gain control through an external variable resistor.
- Increasing the bands by adding resonant circuit or using two KA2223 in series.
- Low noise ($V_{NO} = 7\mu V$: Typ. Flat).
- Low distortion (THD=0.02% Typ. f=1KHz Flat).
- Large allowable input ($V_I = 2.3V$: Typ, $V_{CC} = 9V$, f=1KHz Flat).
- Operating supply voltage range: $V_{CC} = 5V \sim 13V$

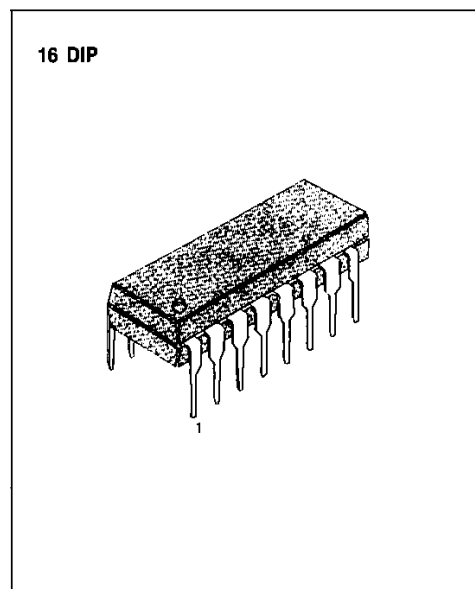

ORDERING INFORMATION

Device	Package	Operating Temperature
KA2223	16 DIP	-20°C ~ +70°C

BLOCK DIAGRAM

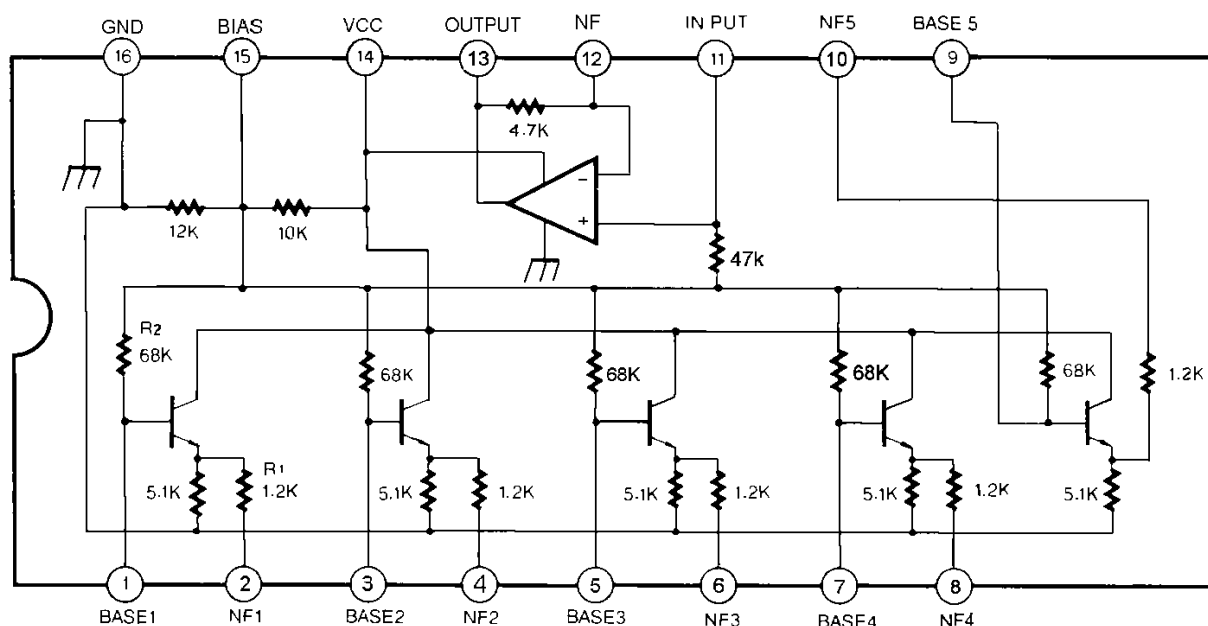

Fig. 1

ABSOLUTE MAXIMUM RATINGS (Ta = 25°C)

Characteristic	Symbol	Value	Unit
Supply Voltage	V_{CC}	20	V
Power Dissipation	P_D	700	mW
Operating Temperature	T_{OPR}	-20 ~ +70	°C
Storage Temperature	T_{STG}	-55 ~ +125	°C

ELECTRICAL CHARACTERISTICS

(Ta = 25°C, Vcc = 9V unless otherwise specified)

Characteristic	Symbol	Test		Min	Typ	Max	Unit	
		f(Hz)	Conditions					
Quiescent Circuit Current	I_{CCQ}		$V_I = 0$	3.0	5.2	8.0	mA	
Voltage Gain	Flat	G_V (Flat)	1K	$V_I = -10\text{dBm}$	-3.8	-0.8	2.2	dB
	Boost	G_V (Boost)	108					
			343	dB				
			1.08K	dB				
			3.43K	dB				
			10.8K	dB				
	Cut	G_V (Cut)	108	$V_I = -10\text{dBm}$	-12	-10.5	-8	dB
			343					dB
			1.08K					dB
			3.43K					dB
10.8K			dB					
Total Harmonic Distortion	THD	1K	$V_I = 1\text{V}$		0.02	0.1	%	
Output Noise Voltage	V_{NO}	Flat, Input Short BW(-3dB) = 10Hz ~ 30KHz			7.0	30	μV	

TEST CIRCUIT

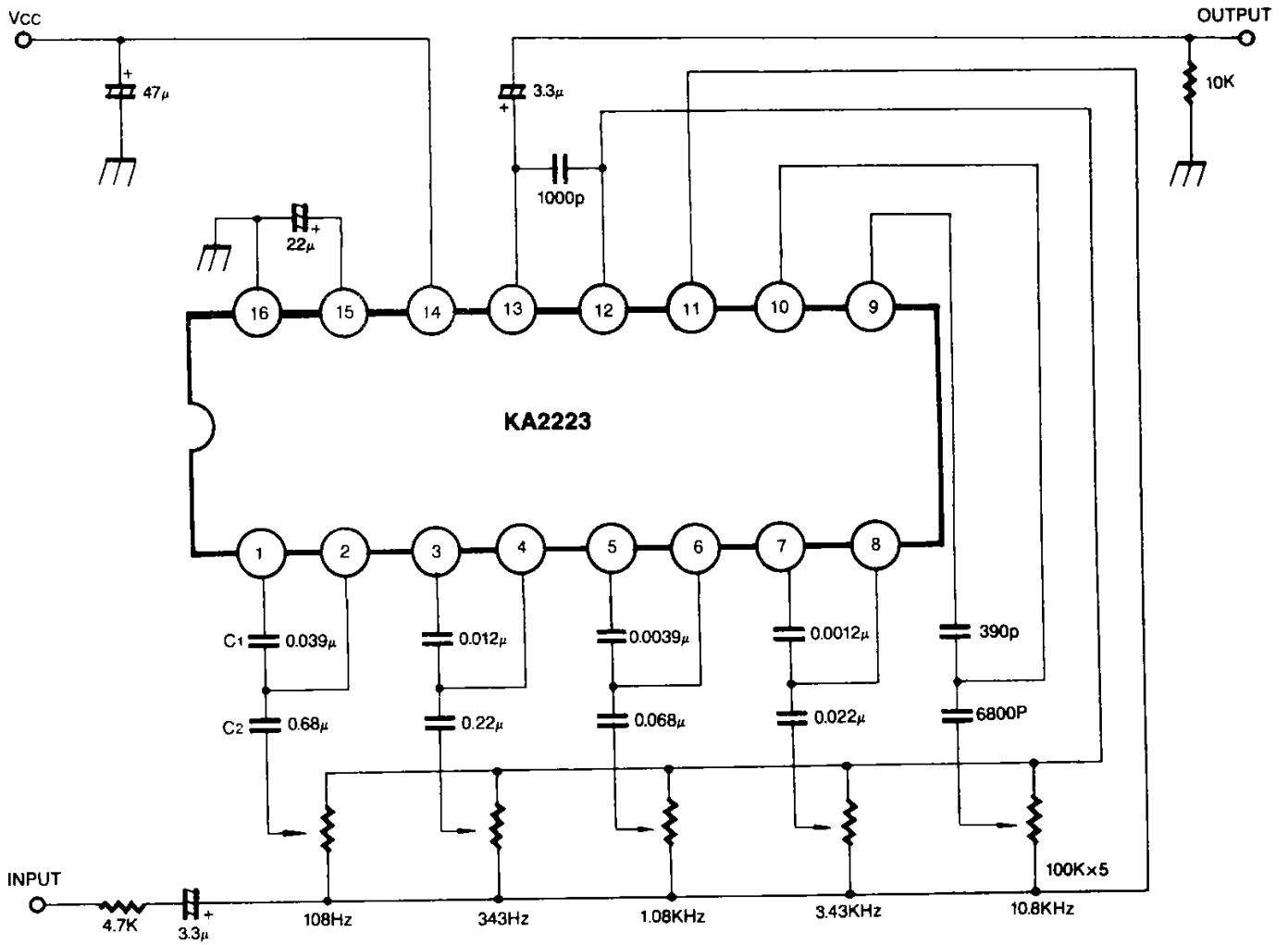

Fig. 2

$$\text{Resonant frequency } f_0 = \frac{1}{2\pi\sqrt{R_1 R_2 C_1 C_2}}$$

(R₁ = 1.2K, R₂ = 68K on-chip resistor)

APPLICATION CIRCUIT

1. 7 BAND

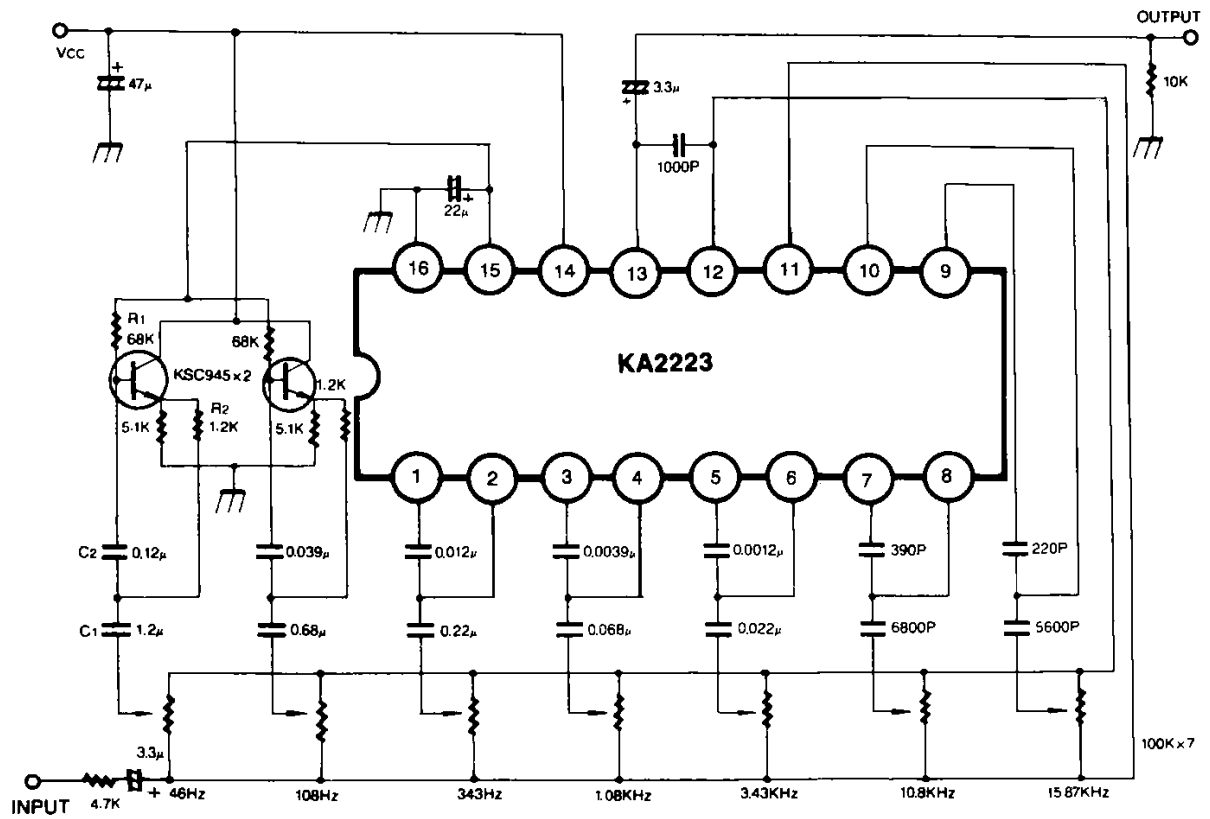

Fig. 3

2. 10 BAND

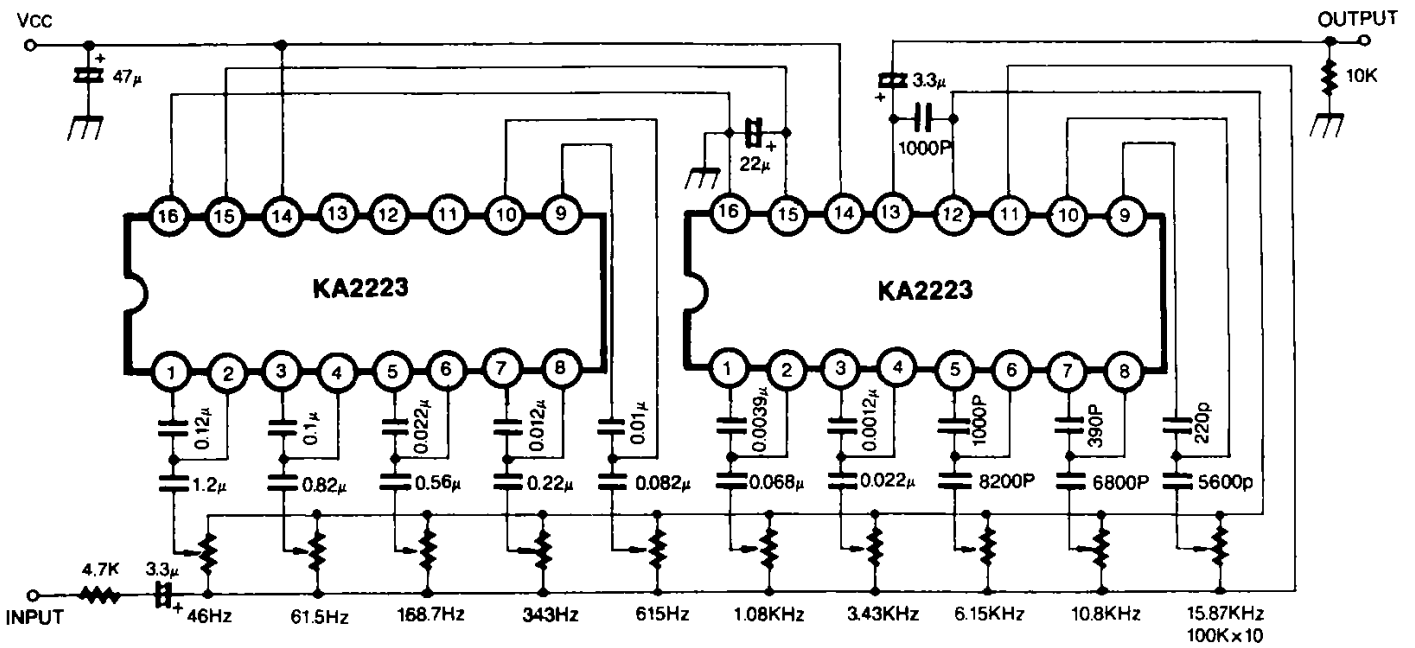

Fig. 4